













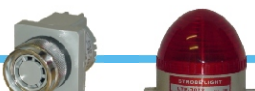

Control & Indicating Devices

22.5mm Ø Push Buttons, Selector Switches & Pilot Lights

Push Buttons		Page 8.2
Emergency Push Buttons		Page 8.3
Pilot Lights		Page 8.4
Selector Switches		Page 8.5
Accessories		Page 8.6
Push Button Stations		Page 8.7
Push Button Station Enclosures		Page 8.8
<u>Push Buttons & Pilot Lights Accessories</u>		
Legends & Lamps		Page 8.9
<u>METAL DOLLY TOGGLE SWITCHES</u>		
Single Pole, Double Pole & Accessories		Page 8.10
<u>Alarm Signal Equipment</u>		
Visual & Audible Signal Equipment		Page 8.11
<u>Rotary CAM Switches</u>		
Isolator & Change-Over Switches		Page 8.12
Change-Over Switches		Page 8.12
Motor Control Switches		Page 8.13
Multi-Step Switches		Page 8.13
Panel Meter Switches		Page 8.13
Accessories		Page 8.13

All Prices Exclude VAT and are subject to change without prior notice.

PUSH BUTTONS, SELECTOR SWITCHES & PILOT LIGHTS

Specifications 22.5 mm diameter single hole mounting
IP65 degree of protection
10 amp 500 volt A.C. Rating

Important: All Actuators supplied complete with **contact block carrier only**.
Order contact block, lampholders & lamps separately.

PUSH BUTTONS

PARTNO COLOUR & DESCRIPTION

FLAT HEAD ACTUATORS

HD15C1		RED
HD15C2		GREEN
HD15C3		BLACK
HD15C4		YELLOW
HD15C5		WHITE
HD15C6		BLUE
HD15C7		ORANGE

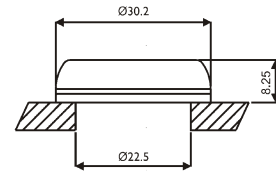

PROJECTING HEAD ACTUATORS

HD45C1		RED
HD45C2		GREEN

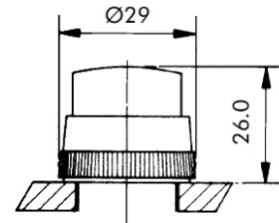

PUSH-PUSH PROJECTING HEAD ACTUATORS

HF45C1		RED
HF45C2		GREEN

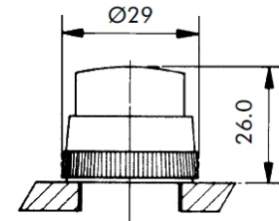

DOUBLE PUSH BUTTON ACTUATORS

HD15G3		RED / GREEN
HD16G7		RED/ GREEN with YELLOW Pilot light indicator

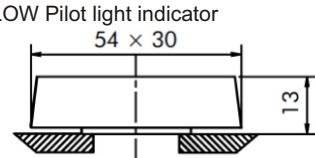

ILLUMINATED FLUSH ACTUATORS

HD16C1		RED
HD16C2		GREEN

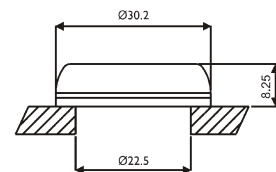

Click here for the **PRICELIST**

PUSH BUTTONS, SELECTOR SWITCHES & PILOT LIGHTS

Specifications 22.5 mm diameter single hole mounting
 IP65 degree of protection
 10 amp 500 volt A.C. Rating

Important: All Actuators supplied complete with **contact block carrier only**.
 Order contact block, lampholders & lamps separately.

EMERGENCY PUSH BUTTONS

PARTNO COLOUR & DESCRIPTION

EMERGENCY STOP MUSHROOM HEAD ACTUATORS

HD55C1

Non-latching

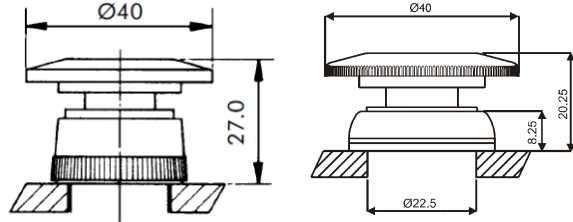

HH55C1

latching - twist release

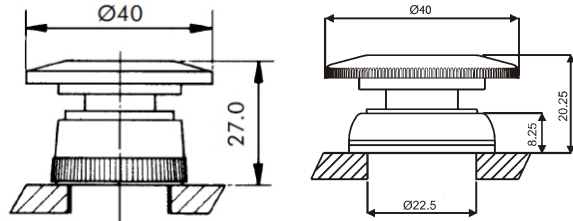

HG55B1

latching - push pull

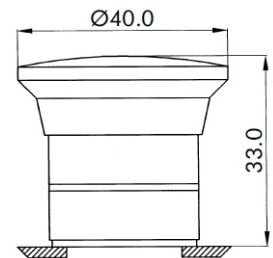

HQ55C1

latching - twist release key operated

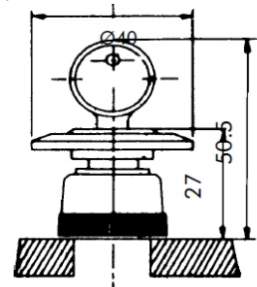

Click here for the **PRICELIST**

PUSH BUTTONS, SELECTOR SWITCHES & PILOT LIGHTS







Specifications 22.5 mm diameter single hole mounting
IP65 degree of protection
10 amp 500 volt A.C. Rating

Important: All Actuators supplied complete with **contact block carrier only**.
Order contact block, lampholders & lamps separately.

PILOT LIGHTS

PARTNO COLOUR & DESCRIPTION

INDICATORS (without Lampholders)



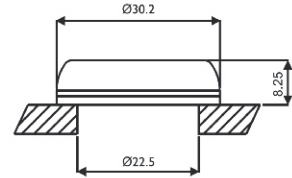











HB08F1		RED
HB08F2		GREEN
HB08F4		YELLOW
HB08F5		WHITE
HB08F6		BLUE
HB08F7		ORANGE



COMPACT INDICATORS (no Lampholders needed) (Discontinued range)

TL01X1		RED
TL02X1		GREEN
TL05X1		WHITE
TL06X1		BLUE
TL07X1		ORANGE

LED PILOT LIGHTS

EILR240A		RED	240v ac
EILG240A		GREEN	240v ac
EILY240A		YELLOW	240v ac
EILW240A		WHITE	240v ac
EILB240A		BLUE	240v ac
EILA240A		AMBER	240v ac
EILR024C		RED	24v ac/dc
EILG024C		GREEN	24v ac/dc
EILY024C		YELLOW	24v ac/dc
EILW024C		WHITE	24v ac/dc
EILB024C		BLUE	24v ac/dc
EILA024C		AMBER	24v ac/dc
EILR415A		RED	415v ac
EILG415A		GREEN	415v ac

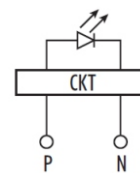
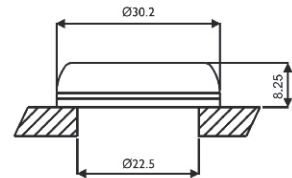

Click here for the PRICELIST

PUSH BUTTONS, SELECTOR SWITCHES & PILOT LIGHTS







Specifications 22.5 mm diameter single hole mounting
IP65 degree of protection
10 amp 500 volt A.C. Rating

Important: All Actuators supplied complete with **contact block carrier only**.
Order contact block, lampholders & lamps separately.

SELECTOR SWITCHES



PARTNO DESCRIPTION

STANDARD SELECTOR SWITCH ACTUATORS

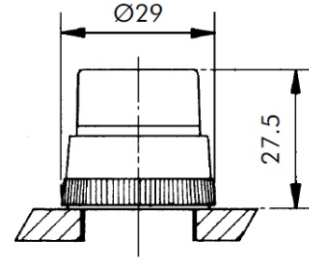
HR65C3		2 position
HI65C3		2 position spring return
HL65C3		3 position
HN65C3		3 position spring return from right
HM65C3		3 position spring return from left
HJ65C3		3 position spring return from left & right





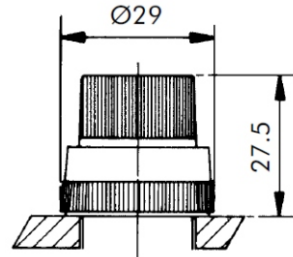

ILLUMINATED SELECTOR SWITCH ACTUATORS

HK66C2		2 position GREEN
HL66C2		3 position GREEN



KEY OPERATED SELECTOR SWITCH ACTUATORS

HT85C3		2 position
HI85C3		2 position spring return
HL85C3		3 position
HN85C3		3 position spring return from right
HJ85C3		3 position spring return from left & right

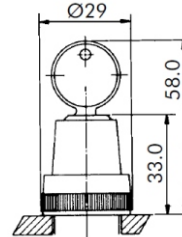
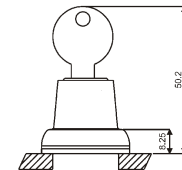

TIP HEAD (TOGGLE) ACTUATOR (Discontinued range)

HP95A3		BLACK
--------	---	-------

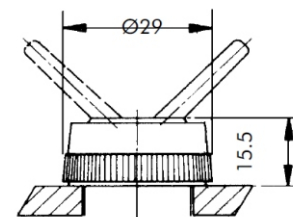

All Prices Exclude VAT and are subject to change without prior notice.

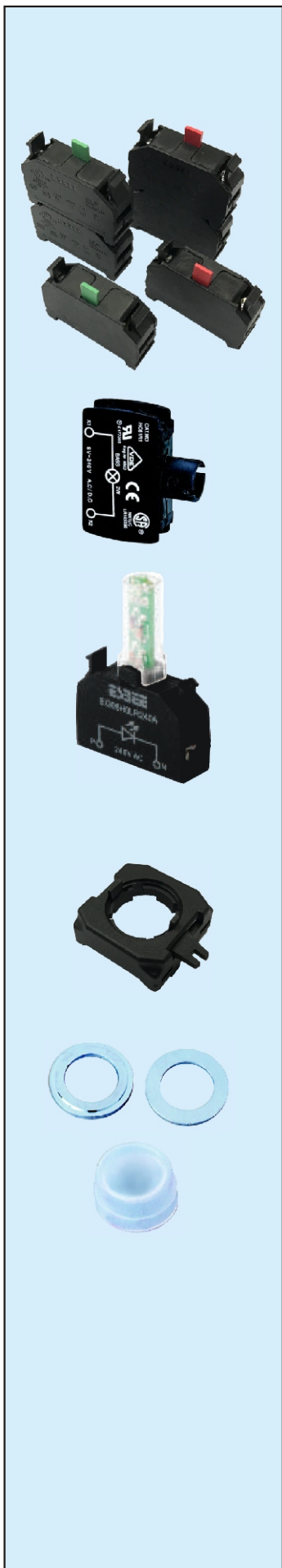

PUSH BUTTONS, SELECTOR SWITCHES & PILOT LIGHTS

Specifications 22.5 mm diameter single hole mounting
 IP65 degree of protection
 10 amp 500 volt A.C. Rating

Important: All Actuators supplied complete with **contact block carrier only**.
 Order contact block, lampholders & lamps separately.

ACCESSORIES

PARTNO	DESCRIPTION
--------	-------------

CONTACT BLOCKS (stackable)

HC61A2	NO contact block - GREEN tip
HC61B2	NC contact block - RED tip

PILOT LIGHT LAMPHOLDERS

HC61R1	Lamp holder for direct supply
HC61X1	Lamp holder with resistor (240/130v for use with 130v BA95 lamps)

LED PILOT LIGHTS for ACTUATORS

EG08HOLR240A	 RED	240v ac
EG08HOLG240A	 GREEN	240v ac
EG08HOLR024C	 RED	24v ac/dc
EG08HOLG024C	 GREEN	24v ac/dc

CONTACT BLOCK CARRIERS

HC922002	First row clip	- for mounting
----------	----------------	----------------

HH180000/1	30mm - 22mm reducing ring
------------	---------------------------

HH150100	Transparent Shroud
----------	--------------------

Click here for the PRICELIST

PUSH BUTTONS STATIONS

Specifications ABS plastic
IP65

PARTNO	DESCRIPTION
--------	-------------

SINGLE FUNCTION STATIONS

JAA10000	Stop station - Grey enclosure
JAB20000	Start station - Grey enclosure

JAE10000	Emergency Stop - Non latching (grey enclosure with yellow cover)
JAF10000	Emergency Stop - Latching (grey enclosure with yellow cover)

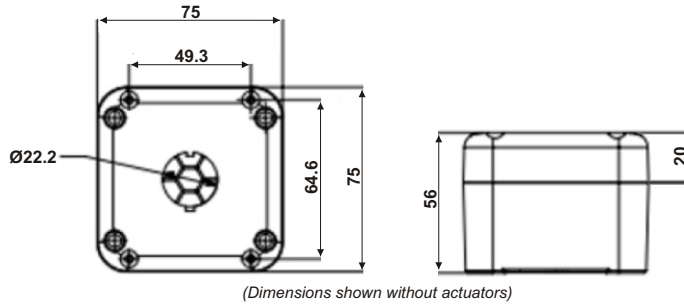

MULTI FUNCTION STATIONS

JBB2A100	Start-Stop station
-----------------	--------------------

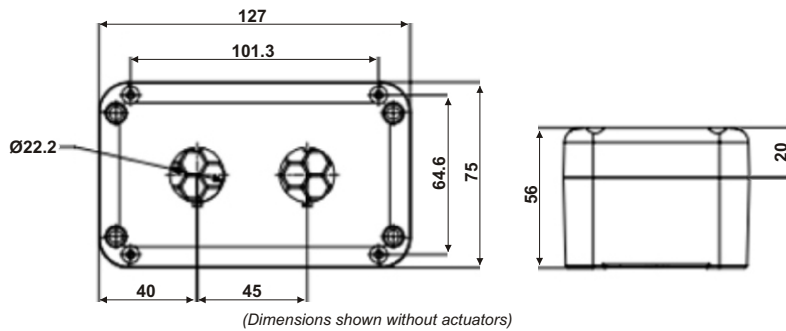

JDB2A1B2	Forward-Stop-Reverse station
JEB2A1B2	Up-Stop-Down station

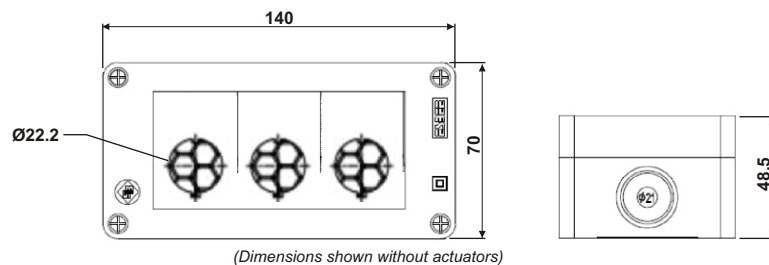

Click here for the **PRICELIST**

All Prices Exclude VAT and are subject to change without prior notice.

PUSH BUTTON STATIONS

Specifications Grey ABS plastic
IP65

PARTNO	DESCRIPTION
--------	-------------

PUSH BUTTON STATION ENCLOSURES (Empty)

- | | |
|-----------------|---|
| HF999004 | 1 hole push button enclosure (ESBEE only) |
| HF999005 | 2 hole push button enclosure (ESBEE only) |
| HF999003 | 3 hole push button enclosure (ESBEE only) |

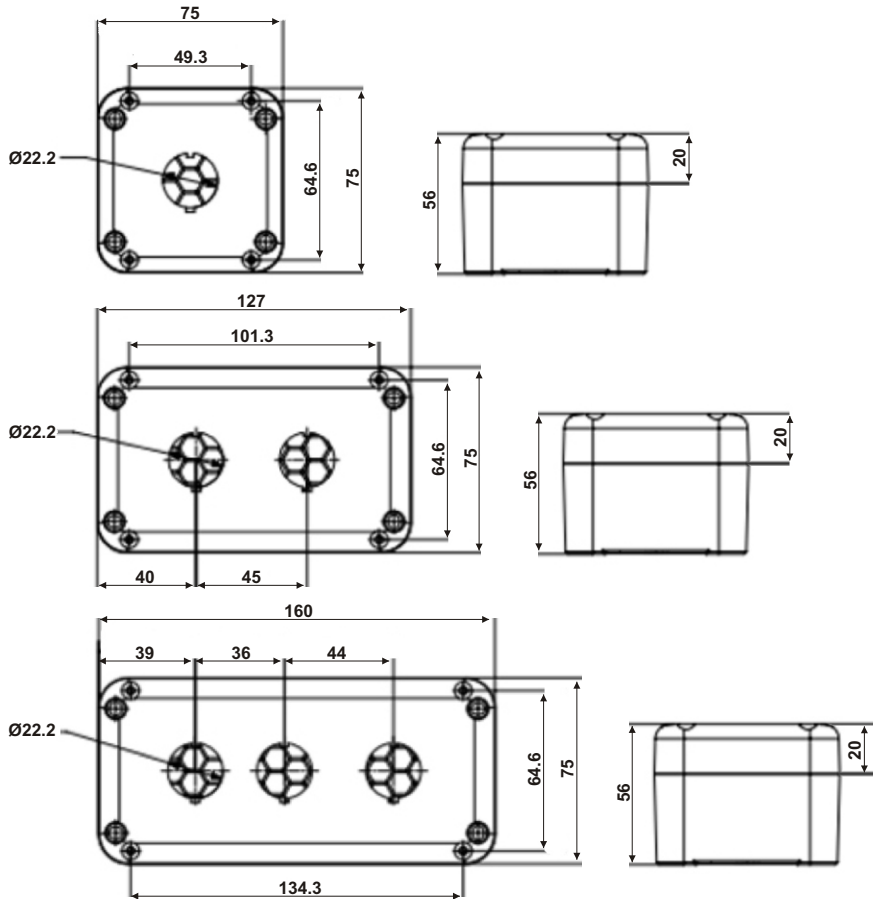

- | | |
|-----------------|--|
| HF999001 | 1 hole all purpose push button enclosure |
| HF999002 | 2 hole all purpose push button enclosure |

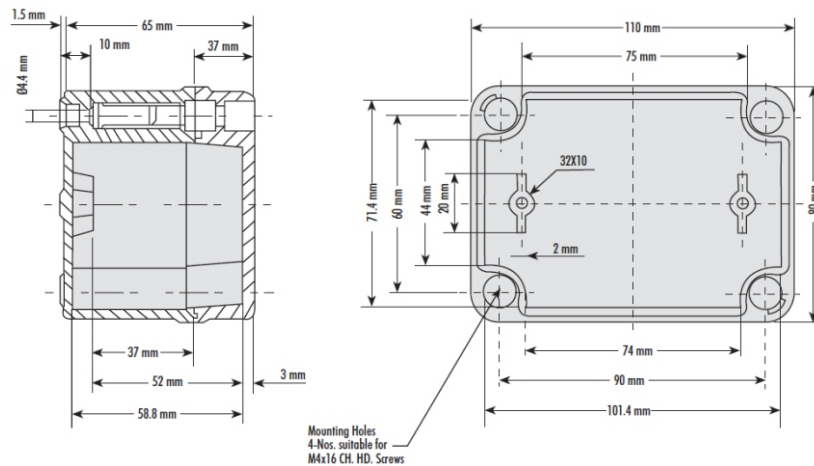

All Prices Exclude VAT and are subject to change without prior notice.

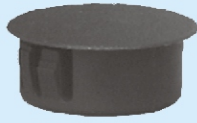

PVC BLANK

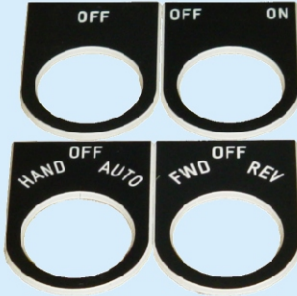

LEGEND PLATES



Ba9s NEON LAMP

PUSH BUTTON & PILOT LIGHT ACCESSORIES

PVC BLANK (Push-in Black)

PARTNO	DESCRIPTION
2703	22.5 mm PVC push buttons & pilot lights blank
2693	20.6 mm PVC blank for starter enclosures
2713	25.4 mm PVC blank for starter enclosures

PLASTIC LEGEND PLATES

Hole size = 22.5 mm

PARTNO	LABEL TEXT	DESCRIPTION
PB102	1-0-2	1-0-2 Label
PBA	ALARM	Alarm Label
PBAC	ALARM CANCEL	Alarm Cancel Label
PBBLANK		Blank Label
PBCLOSED	CLOSED	Closed Label
PBDOWN	DOWN	Down Label
PBESTOP	EMERGENCY STOP	Emergency Stop Label
PBFAULT	FAULT	Fault Label
PBFOR	FWD-OFF-REV	Forward-Off-Reverse Label
PBFWD	FORWARD	Forward Label
PBHL	HIGH LEVEL	High Level Label
PBHLR	HIGH LEVEL RESET	High Level Reset Label
PBHOA	HAND-OFF-AUTO	Hand-Off-Automatic Label
PBLL	LOW LEVEL	Low Level Label
PBLLR	LOW LEVEL RESET	Low Level Reset Label
PBNFLO	NO FLOW	No Flow Label
PBOFF	OFF	Off Label
PBOFF-ON	OFF-ON	Off-On Label
PBOH	OVERHEAT	Overheat Label
PBOHR	OVERHEAT RESET	Overheat Reset Label
PBON	ON	On Label
PBOPEN	OPEN	Open Label
PBPO	POWER ON	Power On Label
PBR	RESET	Reset Label
PBREV	REVERSE	Reverse Label
PBRUN	RUN	Run Label
PBSF	SEAL FAIL	Seal Fail Label
PBSFR	SEAL FAIL RESET	Seal Fail Reset Label
PBSR	START/RUN	Start/Run Label
PBST	START/STOP	Start/Stop Label
PBSTART	START	Start Label
PBSTOP	STOP	Stop Label
PBTRIP	TRIP	Trip Label
PBUP	UP	Up Label
PBNONST	Non-standard Legend Plates	

NEON LAMPS

PART NO	VOLTAGE	TYPE	FOR USE WITH FOLLOWING LENS COLOURS
LR-220	220 VAC	BA9s	Red, Orange & White
LG-220	220 VAC	BA9s	Green & Blue

Click here for the PRICELIST

METAL DOLLY TOGGLE SWITCHES

Current rating: 6 amp 250 VAC
Terminal: Screw type

Panel Hole size: 12 mm diameter
Lever length: 17.5 mm

PARTNO DESCRIPTION

SINGLE POLE TOGGLE SWITCHES

7011	2 position ON/OFF	Single throw
7012	2 position ON/ON	Single throw
7013	3 position change-over ON/OFF/ON	Double throw

DOUBLE POLE TOGGLE SWITCHES

7021	2 position ON/OFF	Single throw
7022	2 position change-over ON/ON	Double throw
7023	3 position change-over ON/OFF/ON	Double throw

ACCESSORIES

WPCBOOT	Rubber protective cover
TOGGON-OFF	ON / OFF Legend plate
TOGGON-ON	ON / ON Legend plate
TOGGON-OFF-ON	ON / OFF / ON Legend plate



SINGLE
POLE
METAL
DOLLY



DOUBLE
POLE
METAL
DOLLY



RUBBER
COVER

Click here for the **PRICELIST**

ALARM SIGNAL EQUIPMENT

VISUAL SIGNAL EQUIPMENT

PARTNO	DESCRIPTION	VOLTAGE
LTE-3072R	RED Strobe Light - 80mm (h) x 75mm Ø	220 VAC
LTE/WMG	Wire mesh guard for strobe light	

Available on request:

Colours: GREEN, BLUE, YELLOW

Voltages: 12VDC, 24VAC, 110VAC



LTE STROBE LIGHT

AUDIBLE SIGNAL EQUIPMENT

PARTNO	DESCRIPTION	VOLTAGE
BF-30	Electronic Panel Buzzer (30mm Ø mounting) dB Rating @ 30cm: 85 dB IP Rating: IP44	220 VAC

Available on request:

Voltages: 24VAC, 110VAC

Time Period must not exceed 5 minutes per operation



BF-30 BUZZER

12VSIREN	15 watt single tone Siren <i>Not continuously rated</i>	12 VDC
-----------------	--	--------



12VDC SIREN

Click here for the **PRICELIST**



Click here for the PRICELIST



TP16 SERIES - ISOLATOR SWITCH



LB SERIES - BLOCK TYPE
PANEL MOUNT

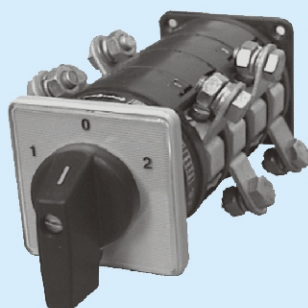

S SERIES - CHANGEOVER CAM SWITCH

ROTARY SWITCHES

Specifications Rated voltage: 415 VAC / 600 VDC
Operating temperature: -25°C to +55°C

ISOLATOR SWITCHES (ON-OFF) - PANEL MOUNT

For BASE mount see accessories on page 8.13

PARTNO	RATED CURRENT AC21 (600 V)	KW AC23 (415 V)	POLES
CAM TYPE			
TP16-61191-B03	16A	7.5	1
TP16-61192-B03	16A	7.5	2
TP16-61199-B03	16A	7.5	3
TP16-61194-B03	16A	7.5	4
S32-61199-B03	32A	15.0	3
S40-61199-B03	40A	18.5	3
S80-61199-B03	80A	30.0	3
S100-61199-B03	100A	37.0	3
S200-61199-B03	200A	37.0	3
BLOCK TYPE yellow/red padlockable handle			
LB225-31309-B33	25A	11.0	3
LB232-31309-B33	32A	15.0	3
LB240-31309-B33	40A	18.5	3
LB263-31309-B33	63A	30.0	3

CHANGEOVER CAM SWITCHES - PANEL MOUNT

For BASE mount see accessories on page 8.13

PARTNO	RATED CURRENT AC21 (600 V)	KW AC23 (415 V)	POLES
NO "OFF" POSITION			
TP16-60151-B03	16A	7.5	1
CENTRE "OFF" POSITION			
TP16-61025-B03*	16A	7.5	1
TP16-61026-B03*	16A	7.5	2
TP16-61027-B03*	16A	7.5	3
TP16-61028-B03*	16A	7.5	4
S32-61028-B03	32A	15.0	4
S40-61028-B03	40A	18.5	4
S63-61028-B03	63A	26.0	4
S80-61028-B03	80A	30.0	4
S100-61028-B03	100A	37.0	4
S200-61028-B03	200A	37.0	4

Replace * with appropriate legend H = HAND - OFF - AUTO
1 = 1 - 0 - 2



ROTARY SWITCHES

Specifications Rated voltage: 415 VAC / 600 VDC
Operating temperature: -25°C to +55°C

MOTOR CONTROL CAM SELECTOR SWITCHES - PANEL MOUNT

For BASE mount see accessories on page 8.13

PARTNO	RATED CURRENT AC21 (600 V)	KW AC23 (415 V)	PHASES	SWITCHING
--------	-------------------------------	--------------------	--------	-----------

STAR DELTA SWITCH

TP16-61200-B03	16A	5.5	3	
----------------	-----	-----	---	--

FORWARD / REVERSING SWITCHES

TP16-61270-B03	16A	5.5	1	
TP16-61211-B03	16A	5.5	3	
S32-61211-B03	32A	11.0	3	

Larger sizes on application

2 SPEED SWITCHES

TP16-61212-B03	16A	5.5	3	(0-1-2)
TP16-61213-B03	16A	5.5	3	(1-0-2)
S32-61212-B03	32A	11.0	3	(0-1-2)

MULTI-STEP CAM SELECTOR SWITCHES (WITH OFF) - PANEL MOUNT

For BASE mount see accessories on page 8.13

PARTNO	RATED CURRENT AC21 (600 V)	KW AC23 (415 V)	POLES	STEPS
--------	-------------------------------	--------------------	-------	-------

TP16-61060-B03	16A	7.5	1	3
TP16-61061-B03	16A	7.5	1	4
TP16-61062-B03	16A	7.5	1	5
TP16-61064-B03	16A	7.5	1	7
TP16-61068-B03	16A	7.5	1	11

PANEL METER CAM SELECTOR SWITCHES

PARTNO	RATED CURRENT AC21 (600 V)	DESCRIPTION
--------	-------------------------------	-------------

AMMETER SWITCH with centre OFF

TP16-61325-B03	16A	Requires 3 CT's
----------------	-----	-----------------

VOLTMETER SWITCHES with centre OFF

TP16-61311-B03	16A	4 position - Line to Neutral
TP16-61312-B03	16A	4 position - Line to Line
TP16-61313-B03	16A	7 position - Line to Line - Line to Neutral

ACCESSORIES

PARTNO	DESCRIPTION
--------	-------------

B33	Yellow / Red padlockable handle for TP16 range
FNC63	Early Make add on block for LB range
DMBTP16	DIN mounting base for TP16 and S32 range
BMPTP16	Base mounting plate for TP16 range
BMPS32	Base mounting plate for S32 range
BMPS40	Base mounting plate for S40 and S63 range
BMPS100	Base mounting plate for S80, S100, and S200 range

All Prices Exclude VAT and are subject to change without prior notice.

